

Unpacking

Before you begin using the device, please check the version you got and ensure that the following items are included in the shipped box:

Universal Accessories:

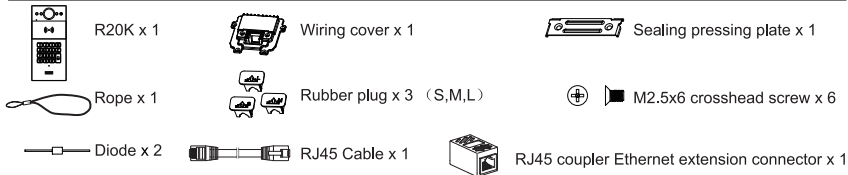

Wall-mounting Accessories :

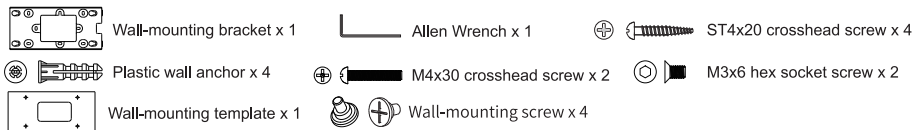

Product Overview



R20K

Installation Environment

Please don't place device under direct sunlight, which will bring bad effect and take damage to device with high temperature.

If installing the device indoors, please keep device at least 2 meters away from light, and at least 3 meters away from window and door .

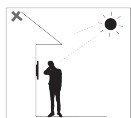

Backlight

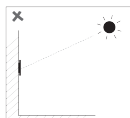

Direct sunlight

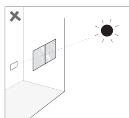

Direct sun through window



Indirect sunlight through window

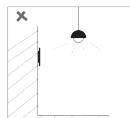

Close to light

Wall-mounting Installation

Step1: Wall-mounting Bracket Installation

1. With embedded one-gang junction box (86x86 mm or 2x3 inches in size) in the wall.

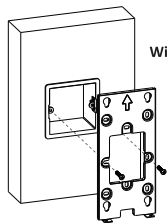

With 86x86 mm junction box.

Fix the wall-mounting bracket on 86x86 mm junction box with two M4x30 crosshead screws.

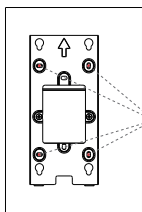

Mark the four holes of the wall-mounting bracket on the wall. Then take down the wall-mounting bracket and two screws.

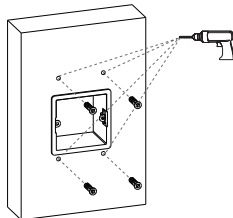

Use a hand drill with 6 mm diameter bit to drill four screw holes with a depth of 25 mm at the marked positions. Then insert four plastic wall anchors into the holes.

or

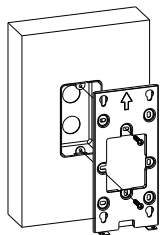

With 2x3 inches junction box

Fix the wall-mounting bracket to the 2x3 inches junction box with two M4x30 crosshead screws.

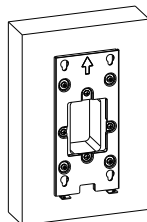

Finish the wall-mounting bracket installation.

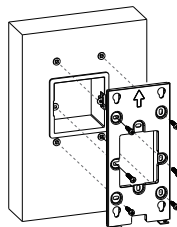

Fix the wall-mounting bracket with two M4x30 crosshead screws and four ST4x20 crosshead screws.

2. Without embedded junction box in the wall

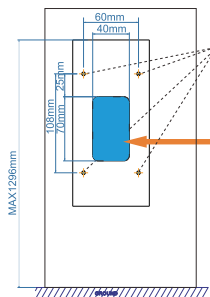

According to the wall-mounting template, use a hand drill with 6 mm diameter bit to drill four screw holes with a depth of 25 mm and cut a rectangular hole on the wall of the diameter of 40x70 mm and depth of 40 mm that can accommodate and through out all necessary cables.

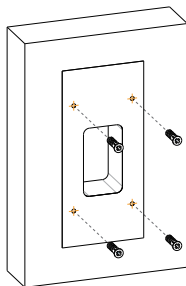

Insert four plastic wall anchors into the holes.

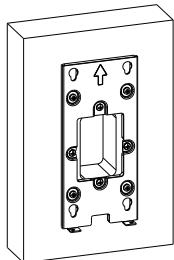

Finish the wall-mounting bracket installation.

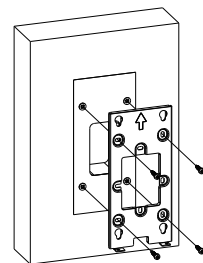

Fix the wall-mounting bracket with four ST4x20 crosshead screws.

Step2: Wiring Cover Installation

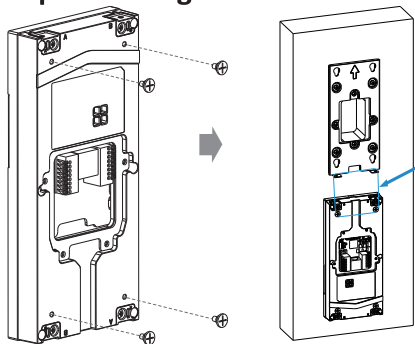

Install 4 wall-mounting screws to the back of device.

For convenient wiring, hang R20K on the wall-mounting bracket with rope.

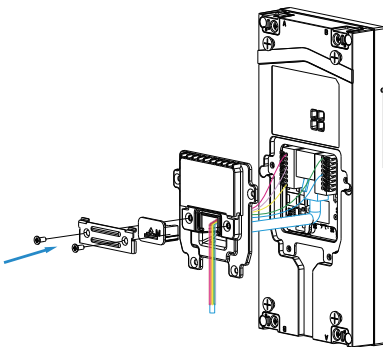

Make cables go through the wiring cover, connecting to the corresponding interfaces of the main board. Select a suitable size rubber plug to push all the cables into the wiring cover. Fix sealing pressing plate to the wiring cover with two M2.5x6 crosshead screws.

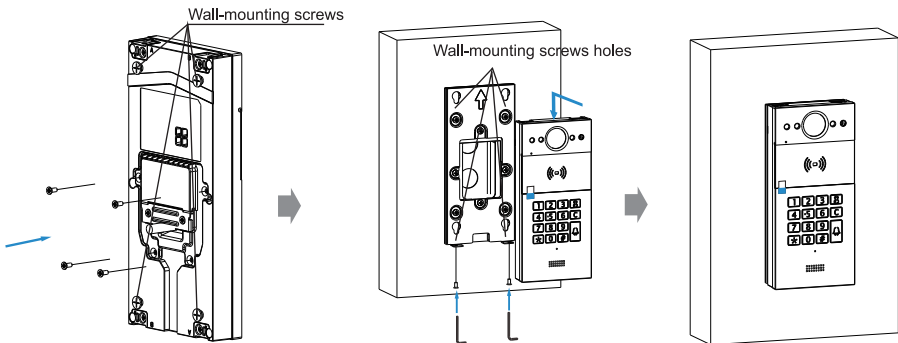

Fasten the wiring cover with four M2.5x6 crosshead screws.

Insert the four wall-mounting screws on the device into the corresponding holes on the wall-mounting bracket, and then press down to slide the wall-mounting screws into the groove. Then use the Allen Wrench to tighten the device with two M3x6 hex socket screws.

Installation is completed, please remove the protect film.

Device Wiring

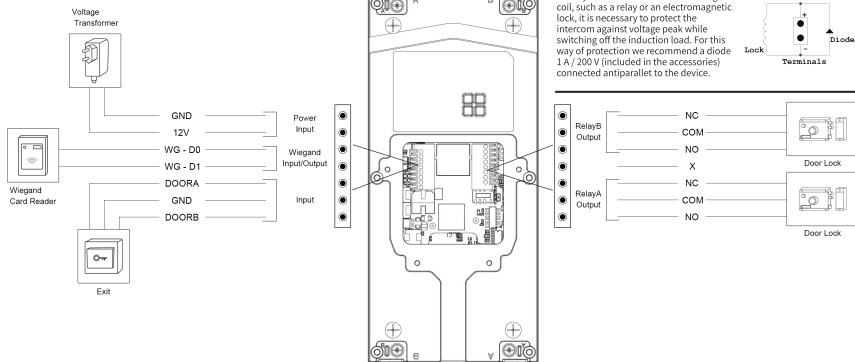

Wire Length & AWG Table

Please follow the properly measured wire gauge/length to install device:

	20 AWG	22 AWG	24 AWG	26 AWG
12V 1A Adapter	≤50m	≤40m	≤20m	\

Application Network Topology

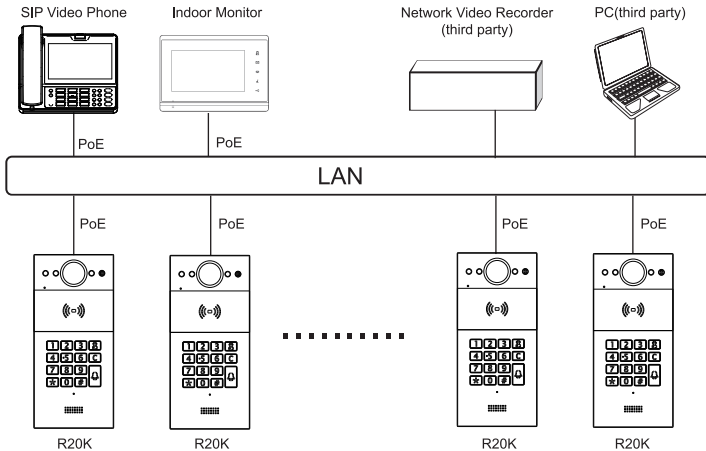

IP Announcement

1. While R20K starts up normally, press *3258*, voice system will enter IP announcement mode.
2. In announcement mode, the IP address will be announced periodically.
3. Press **Cancel Button** again to quit the announcement mode.
4. In announcement mode, phone announces "IP 0.0.0.0" if no IP address is gained.

Configuration

1. Access the Web UI: Input the IP address into web browser to configure the phone.
2. Account Registration: On web UI, go to the path: **Account > Basic** page to register account and fill in the account information. (Please refer to admin guide for more information)
3. Configure the Push Button: On web UI, go to the path: **Intercom > Basic > Push Button** to configure the call number.
4. Configure the code to open the relay: On web UI, go to the path: **Intercom > Relay > Relay ID/DTMF** and choose the DTMF code number in corresponding area.

Operation

Make a call:

Press the SIP number or IP address and dial key to make a call.

Receive a call:













R20K supports Auto Answer by default. Incoming call will be answered automatically.

Unlock:

1. During the talk, called party can press pre-configured code number to unlock the door;
2. Scan the predefined RFID card nearby the card reader to unlock;
3. Press the predefined pin code to unlock.

Indicators

 Light ON  Light OFF

Name	Status		Description
Status indicator	Blue		Normal status
		 0.25sec → 	Calling
	Red	 0.05sec → 	Restarting
		 0.25sec → 	Network is unavailable
	Green		Initialing/Talking on a call
		 0.25sec → 	Receiving a call
Red/Blue	 0.05sec →  0.05sec	Firmware upgrading	

Note: For more LED settings, please refer to R20K webUI: Intercom > LED Setting.

Notice Information

Akuvox R20K firmware contains third-party open source software under the terms of the GNU General Public License(GPL). Akuvox is committed to meeting the requirements of the GNU General Public License (GPL) and will make all required source code available.

The source code of software under the terms of GNU GPL can be downloaded online: <http://www.akuvox.com/gpl>.

Information contained in this document is believed to be accurate and reliable at the time of printing. This document is subject to change without notice, any update to this document can be viewed on Akuvox' s website: <http://www.akuvox.com> © Copyright 2022 Akuvox Ltd. All rights reserved.



AKUVOX (XIAMEN) NETWORKS CO., LTD.

Add.: 10/F, NO.56 GUANRI ROAD, SOFTWARE PARK II, XIAMEN 361009, CHINA
www.akuvox.com

