

# Outdoor CPE

## Quick Installation Guide

### Device installation

Passive PoE Adapter supports up to 60 meters (200 feet) Power over Ethernet deployment

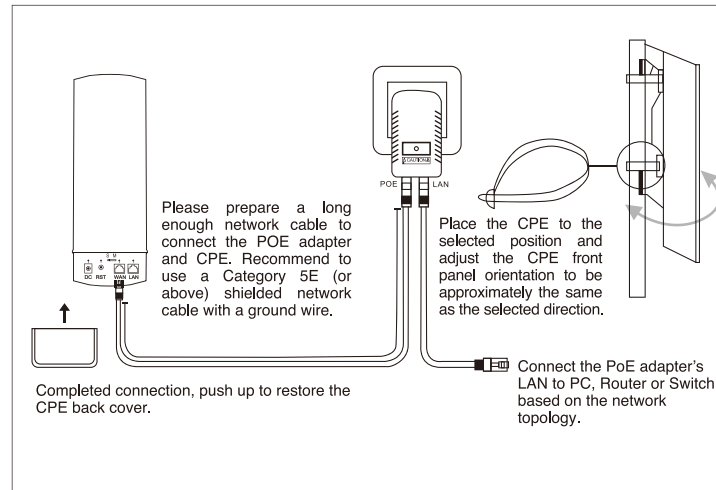

### Wireless Connection Topology

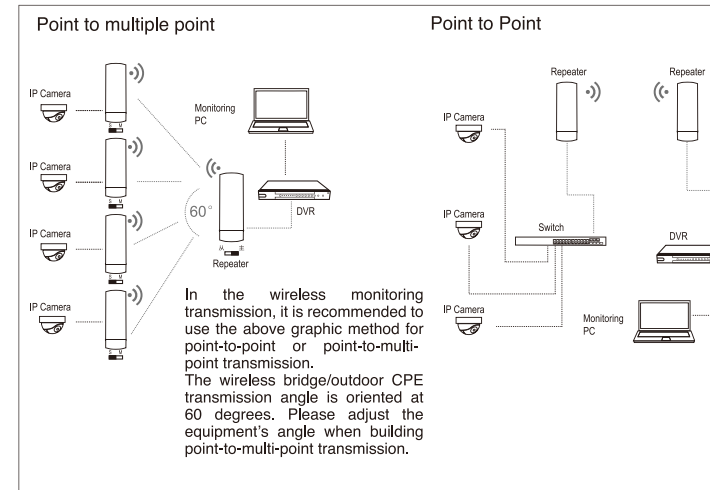

### LED Display CPE

1. Default working mode is Slave CPE or Client, IP: 192.168.188.253
2. Set one CPE to Master CPE or Host, in LED Display will start with "H":

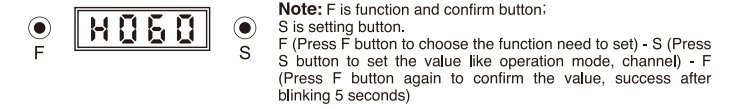

3. Master CPE channel must be same as Slave CPE:



4. Press Reset 1 second on both side, the two outdoor devices will start bridging:

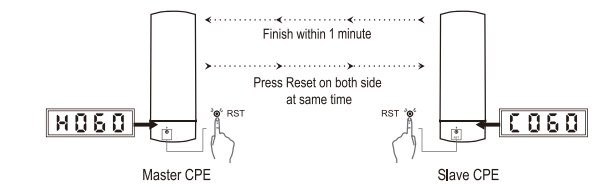

### WEB Configuration

1. PC configuration if PC connect CPE by wireless

Connect to CPE's wireless SSID: Wireless 2.4G\_XXXXXX/Wireless 5.8G/Wireless 5.8G\_XXXXXX, wireless key: 66666666.  
Set PC wireless network IP to 192.168.188.x(x: 11-200), same network segment as CPE, subnet mask: 255.255.255.0

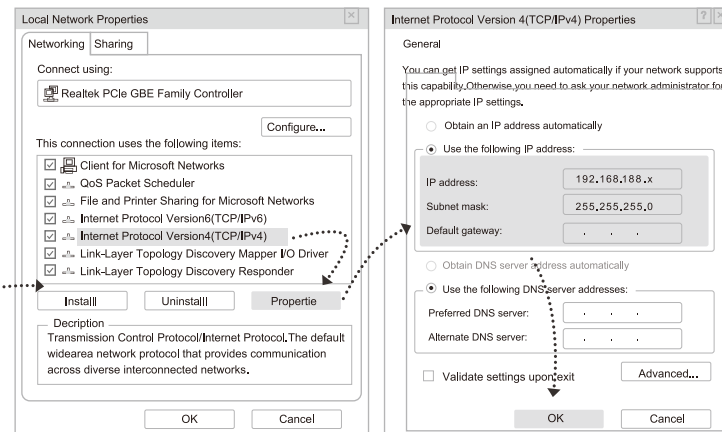
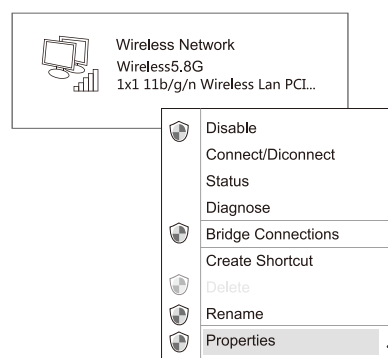

2. PC configuration if PC connect CPE wired

If connect PC and CPE wired, Set PC local network IP to 192.168.188.x(x: 11-200), same network segment as CPE, subnet mask: 255.255.255.0:

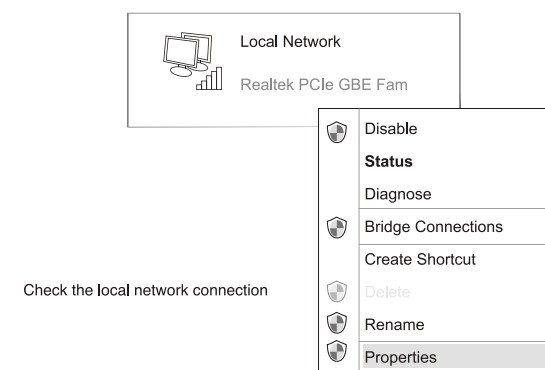

Check the local network connection

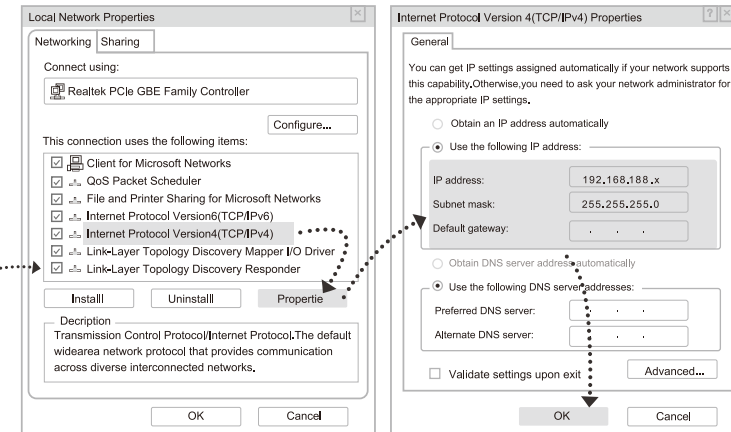

Set Static IP address for PC

### 3. Login Web Configuration

Use IE browser to access <http://192.168.188.253>, pop up the login page shown below, input the login password: admin, enter into the home page.

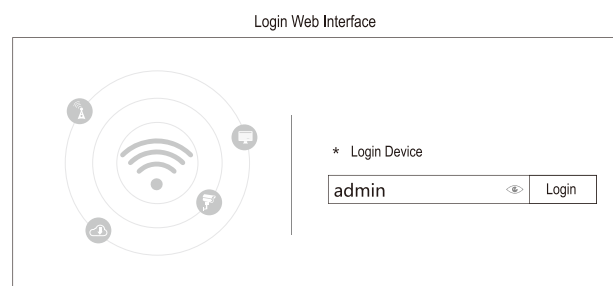

### Setup Wizard

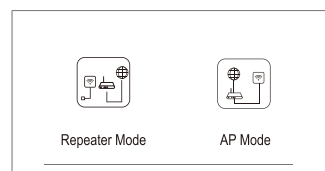

Using Setup Wizard the CPE device can be set up to Repeater and AP mode.

- Repeat mode**  
 Bridge the exist wireless signal then transmit Wi-Fi for more range.
- AP mode**  
 In this mode, NAT, DHCP, firewall, and all WAN-related functions are turned off. All wireless and wired interfaces are bridged together, regardless of LAN and WAN.
- Configuration method**  
 According to the quickly setup wizard of each mode shown in the above figure, set the parameters and options based on user needs, click next until the setting of each step is completed.

### 4. Configure Wireless

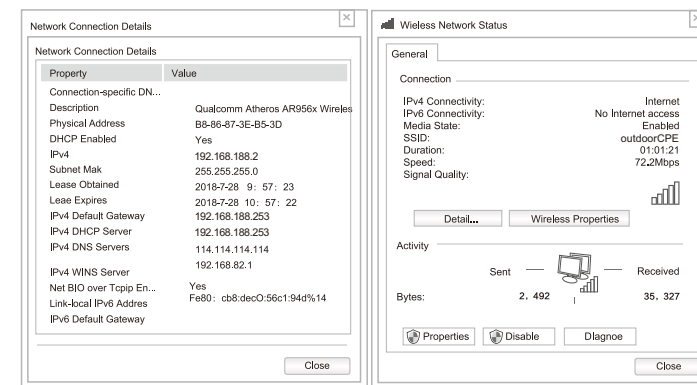

- Use a laptop or mobile phone to test the wireless network Internet, click on the wireless network, select the wireless SSID, input the password to test whether PC or mobile phone can be online.
- Check the wireless network connection status, signal strength and speed, transmission and data, click network connection details to see if the IP address and DNS server address are correctly obtained, confirm device is working properly.

### 5. Login WEB by Mobile Phone

Outdoor CPE supports mobile phone Login and set, the configure page showed as follow:

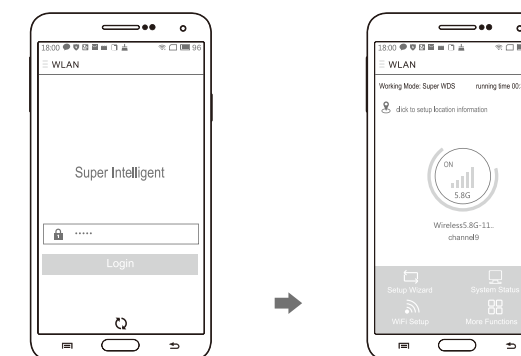

- Mobile phone connect with outdoor CPE, SSID: Wireless 2.4G\_XXXXXX/Wireless 5.8G/Wireless 5.8G\_XXXXXX, wireless key: 66666666.
- Configure static IP:
  - **Android Mobile Phone:** Open settings in phone, turn on WLAN and find the SSID of the CPE, access to wireless network settings then choose "static IP" in the menu, set the mobile phone IP address as 192.168.188.x (x: 11--200 ) same network segment as CPE, subnet mask: 255.255.255.0, then gateway, subnet mask and domain.
  - **IOS Mobile Phone:** Open settings and choose wi-fi connect with CPE, click exclamation mark (!), manual set IP address 192.168.188.x (x: 11--200 ) same network segment as CPE, subnet mask: 255.255.255.0, then gateway, subnet mask and domain.
- Input 192.168.188.253 on the internet explorer bar, input admin to login the mobile configuration page.
- Login password: admin

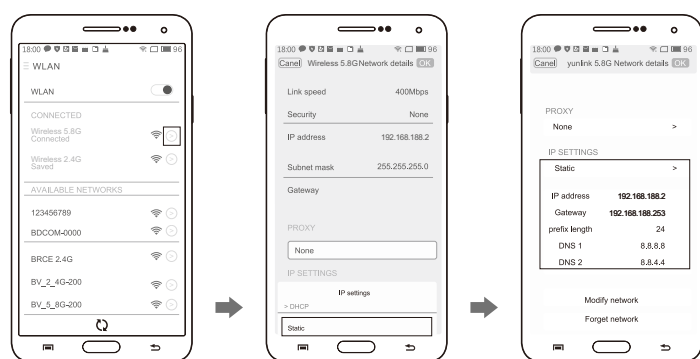

①. Android system setup steps

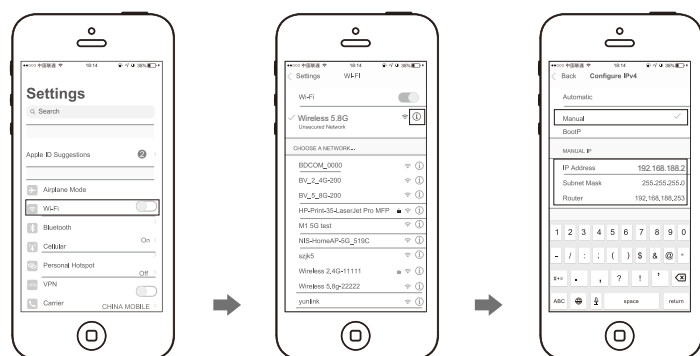

②. IOS system setup steps

### Channel Table

#### Wireless Bridge Regional Channel Code Instructions

Regional Code	5G Channel	
ETSI	5.500GHz	(Channel 100)
	5.520GHz	(Channel 104)
	5.540GHz	(Channel 108)
	5.560GHz	(Channel 112)
	5.580GHz	(Channel 116)
	5.600GHz	(Channel 120)
	5.620GHz	(Channel 124)
	5.640GHz	(Channel 128)
	5.660GHz	(Channel 132)
	5.680GHz	(Channel 136)
5.700GHz	(Channel 140)	

(Note: for the frequencies above indicated the DFS function must be activated)

### Trouble shooting

Trouble	Reason	Solution
Packet Latency	1. Wireless Interference 2. Distance is too long, or there are some bar between them 3. CPE's angle in wrong direction, weak signal	1. Use Wi-Fi analysis to choose the best channel, or change to 5G CPE 2. CPE should be in normal distance, and avoid bar 3. Adjust the angle of CPE according to signal strength
Wrong password	1. Forget password 2. Input wrong password 3. Too much cookie	1. Press reset button in 10 seconds to reset device, the default password is admin 2. Re-input the password 3. Clear cookie, run arp -d to clear MAC table
Can not login WEB	1. Local IP is not in the same network segment of CPE 2. IP is taken by other devices 3. LAN Connection or Ethernet cable has problem 4. Too much cookie, MAC address haven't update	1. Ping 192.168.188.253 to see connection status 2. Stop other devices or change to another IP 3. Check LAN Connection and Ethernet cable problem 4. Clear cookie, run arp -d to clear MAC address
System LED light off	1. PoE power supply is not working 2. Some problem in CPE's PoE port 3. Ethernet cable is loose, RJ45 port is wrong Power current/voltage lower or wrong	1. Check if POE Adapter or POE switch work 2. Check if POE port of CPE is OK 3. Check if Ethernet cable is loose, if Ethernet cable plugged in to POE port 4. Check if voltage is normal, if socket has problem, if input voltage of POE adapter is normal
Low transmission Rate	1. Packet Latency 2. Ethernet cable circuit 3. Network virus attack 4. Too much access users	1. Adjust the distance, angle and channel to decrease latency 2. Check the connection of the network cable 3. Check if port isolated to avoid network virus and broadcast storm 4. Decrease the access users
Device always Dead	1. Static electricity 2. Running time too long 3. Lightning stroke	1. Make CPE or POE adapter need ground connection 2. Reboot CPE device 3. After lightning, device POE port broken or unstable, better to deploy lightning conductor